

TURTLE

MINEOLA 4x4 DANTE BRIDGE



User Manual

Thank you for purchasing this product

For optimum performance and safety, please read these instructions carefully before connecting, operating or adjusting this product. Please keep this manual for future reference.

Table of Contents

- 1. Introduction..... 1
- 2. Features. 1
- 3. Package Contents..... 1
- 4. Specifications..... 2
- 5. Operation Controls and Functions. 3
 - 5.1 Front Panel..... 3
 - 5.2 Rear Panel..... 4
- 6. Dante Web GUI Operation Guide..... 5
- 7. API Control Command 12
- 8. Connection Diagram. 22



1. Introduction

The **Mineola 4x4 Dante Bridge** is a professional-grade audio interface designed to seamlessly integrate analog audio systems with Dante digital audio networks. Featuring four analog inputs and four analog outputs, it enables high-quality bi-directional conversion between XLR-based analog signals and Dante audio streams.

Each input supports XLR/TRS combo connectors, accommodating both balanced and unbalanced sources, with selectable 48V phantom power and adjustable input sensitivity. The outputs provide flexible level control to suit a wide range of professional audio applications.

Built-in DSP capabilities—including gain adjustment, equalization, and delay—allow for precise audio tuning directly within the unit. Configuration and control are straightforward via the integrated web interface or standard Dante Controller software. The device supports both primary and secondary Dante networks for redundancy, ensuring reliable operation in critical environments.

Housed in a compact 1U rack-mount chassis, the Mineola 4x4 can be powered via dual PoE or a local DC supply, offering flexible installation options. It provides a cost-effective and scalable solution for professional AV systems, simplifying system design while maintaining high performance and reliability.

2. Features

- 4x balanced analog inputs on XLR, supporting XLR/TRS combo connection
- 4x balanced analog outputs on XLR
- Dante 4x4 and AES67 audio input/output supported
- Supports balanced/unbalanced analog audio input and output
- 2x RJ45 Dante connectors with redundancy and dual PoE+, supporting Dante primary and backup networks
- Each input supports +48V phantom power
- Adjustable global 0dBFS line up selection (6-level input sensitivity adjustment: -35dBV/-18dBV/0dBV/+4dBu/+14dBu/+24dBu; 5-level output adjustment: +20dBu/+14dBu/+4dBu/0dBV/-18dBV)
- Built-in audio DSP processing for sensitivity, gain, 8-band PEQ and delay control
- Audio input and output support 8 band PEQ adjustment (with +15dB/-15dB gain), and a maximum of 50ms delay setting
- Dante audio supports: 44.1kHz, 48kHz, 88.2kHz, and 96kHz sampling rates @ 16/24bit
- Dante audio delay supports settings of 2, 3, 4, 5, 10ms
- Configuration using internal Web GUI or Dante Controller
- Powered by PoE+ or local DC power supply
- Standard 1U 19" rack-mount form factor

3. Package Contents

- ① 1x 4x4 XLR Audio Bridge with Dante and PoE+
- ② 1x 12V/2.5A Locking Power Supply with Optional Multinational Conversion Plug
- ③ 2x Mounting Ear
- ④ 8x Machine Screw
- ⑤

4. Specifications

Technical	
Network Bandwidth	Dante Network 1000M
Audio Latency	Configurable Dante device latency: (Supports 2, 3, 4, 5, 10ms configurable using Dante Controller) Internal latency: up to 18ms
Audio Format	DANTE [Dante /AES67 digital audio in/out, PCM 2CH 44.1K-96KHz, 16/24Bit] LINE IN [Analog audio, Balanced/unbalanced, Max input level 24dBu] MIC IN [Analog audio, Balanced/unbalanced, Min input level -35dBV] LINE OUT [Analog audio, Balanced/unbalanced, Max output level 20dBu, Min output level -18dBV]
Line/Mic Input Audio	
Input Impedance	20K Ohm balanced 10K Ohm unbalanced
Input Level	Max 24dBu (12.28Vrms) @ balanced line audio Max 18dBu (6.14Vrms) @ unbalanced line audio Min -35dBV (17.78mVrms) @ balanced mic audio
Line Output Audio	
Output Impedance	600 Ohm balanced 300 Ohm unbalanced
Output Level	Max 20dBu (7.75Vrms) @ balanced audio Max 14dBu (3.875Vrms) @ unbalanced audio
Frequency Response	20Hz to 20kHz (-/+0.5dB)
Dynamic Range	≥ 105dB@ +4dBu, 1kHzA-weighted
Audio S/N Ratio	≥ 105dB@ +4dBu, 1kHzA-weighted
Audio THD+N	< 0.01% at +4dBu, 1kHz
Transmission Distance	328ft/100m (CAT6/6A/7)
ESD Protection	IEC 61000-4-2: ±8kV (Air-gap discharge) , ±4kV (Contact discharge)

Connection	
4x MIC/LINE INPUTS [XLR/TRS Combo, female] [Line analogue audio, Balanced/unbalanced 4CH, Max input level 24dBu] [Mic analogue audio, Balanced/unbalanced 4CH, Min input level -35dBV]	
4x LINE OUTPUTS [XLR, male] [Analogue audio, Balanced/unbalanced 4CH, Max output level 20dBu]	
1x DANTE PRIMARY [RJ45 locking connector, PoE+/PD (Class 4 IEEE 802.3at)] [Dante/AES67 digital audio in/out, PCM 2CH 44.1K-96KHz 16/24Bit, Web GUI and TCP/IP]	
1x DANTE SECONDARY [RJ45 locking connector, PoE+/PD (Class 4 IEEE 802.3at)] [Dante/AES67 digital audio in/out, PCM 2CH 44.1K-96KHz 16/24Bit]	
1x DC 12V IN [2-pin DC Locking Power Jack, Max 2.5A]	
Mechanical	
Housing	Metal Enclosure
Color	Black
Dimensions	440mm [W]×200mm [D]×44mm [H]
Weight	2.14kg
Power Supply	(1) 12V/2.5A 2PIN Locking Power Supply (2) PoE/PD (Class 4 IEEE 802.3af)
Power Consumption (Max)	10.2W (Test with 1Hz sine wave)
Operating Temperature	0°C ~ 40°C / 32°F ~ 104°F
Storage Temperature	-20°C ~ 60°C / -4°F ~ 140°F
Operating Humidity	20%~80% (relative humidity, non-condensing)
Storage Humidity	10%~90% (relative humidity, non-condensing)

5. Operation Controls and Functions

5.1 Front Panel

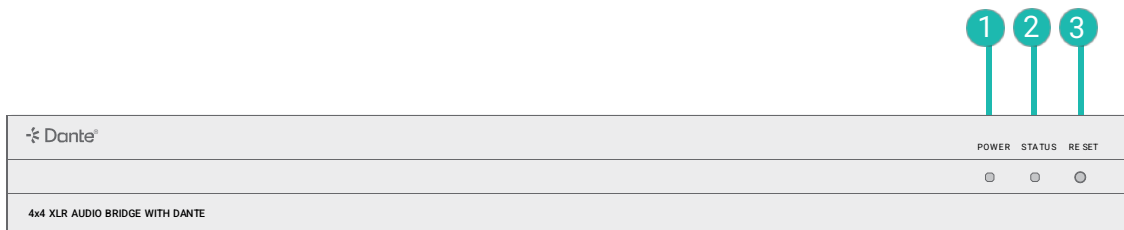

No.	Name	Function Description
1	POWER LED	<ul style="list-style-type: none"> Green ON: The system is powered on (PoE+ or DC power supply). Red ON: The system is in standby mode. OFF: The system is powered off.
2	STATUS LED	System status indicator. <ul style="list-style-type: none"> Green ON: The system is normal. Flash at 2Hz: The system is abnormal.
3	RESET button	<ul style="list-style-type: none"> Short press this button to reset the system. Press and hold this button for 5 seconds to restore the product to factory default settings, all LEDs on the front panel will flash at 2Hz for 5 seconds.

5.2 Rear Panel

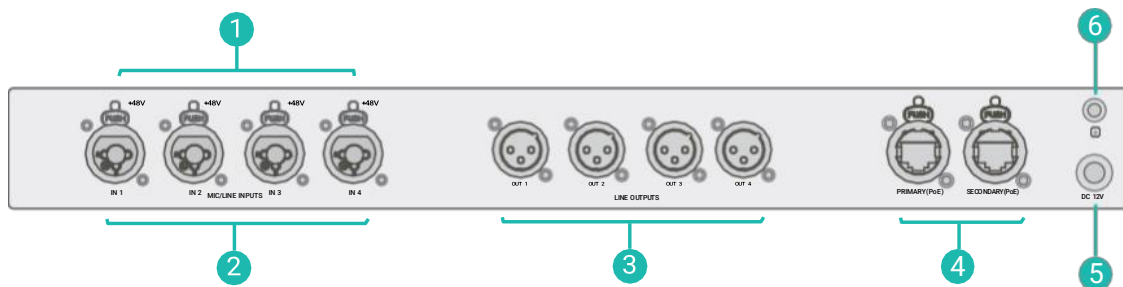

No.	Name	Function Description
1	48V phantom power indicator lights	Four 48V phantom power indicator lights. When the MIC/LINE IN 1/2/3/4 port is used as a MIC input port, and the corresponding 48V phantom power is turned on, the corresponding green indicator light is on.
2	MIC/LINE INPUTS ports	<ul style="list-style-type: none"> LINE analogue audio input port, supporting balanced/unbalanced 4CH, with a Max input level of 24dBu. MIC analogue audio input port, supporting balanced/unbalanced 4CH, with a Min input level of -35dBV. Note: These ports support 48V phantom power. When the phantom power function is turned on through Web GUI or API commands, these ports can supply power to the connected MIC.
3	LINE OUTPUTS ports	LINE analogue audio output ports, supporting balanced/unbalanced 4CH, with a Max output level of 20dBu.
4	PRIMARY(PoE) /SECONDARY (PoE) port	Dante primary/secondary network port, supporting PoE+, with the following two functions: (1) Dante audio input and output port. (2) Web GUI and TCP/IP control port . Note: The primary and secondary networks of this product are hot backup networks, that is, when the primary network encounters a problem, it will automatically switch to the secondary network.
5	DC 12V	DC 12V/2.5A power input port.
6	GND	Connect the unit housing to the ground.

1. Dante® Web GUI User Guide

The audio bridge can be controlled by the built-in Dante® Web GUI. The operation steps are as following.

Step 1: Connect the Dante® PRIMARY(PoE) port of the audio bridge to the Ethernet Switch.

Step 2: Connect the PC to the same Ethernet Switch, and set the Network connection setting of PC to be “Obtain an IP address Automatically”.

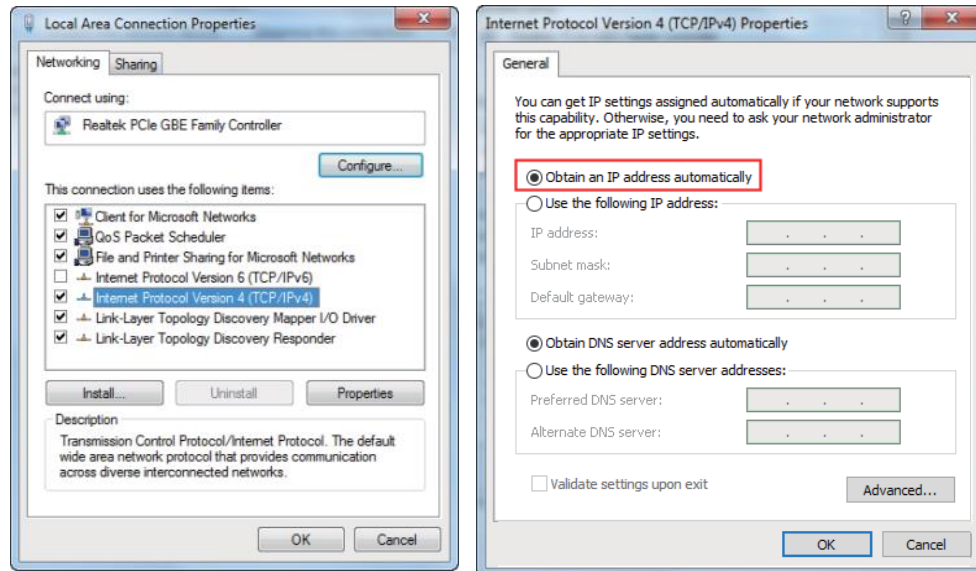

Step 3: Open the Dante® Controller software on the PC, and find the Dante® device on the Routing page, as shown in the figure below.

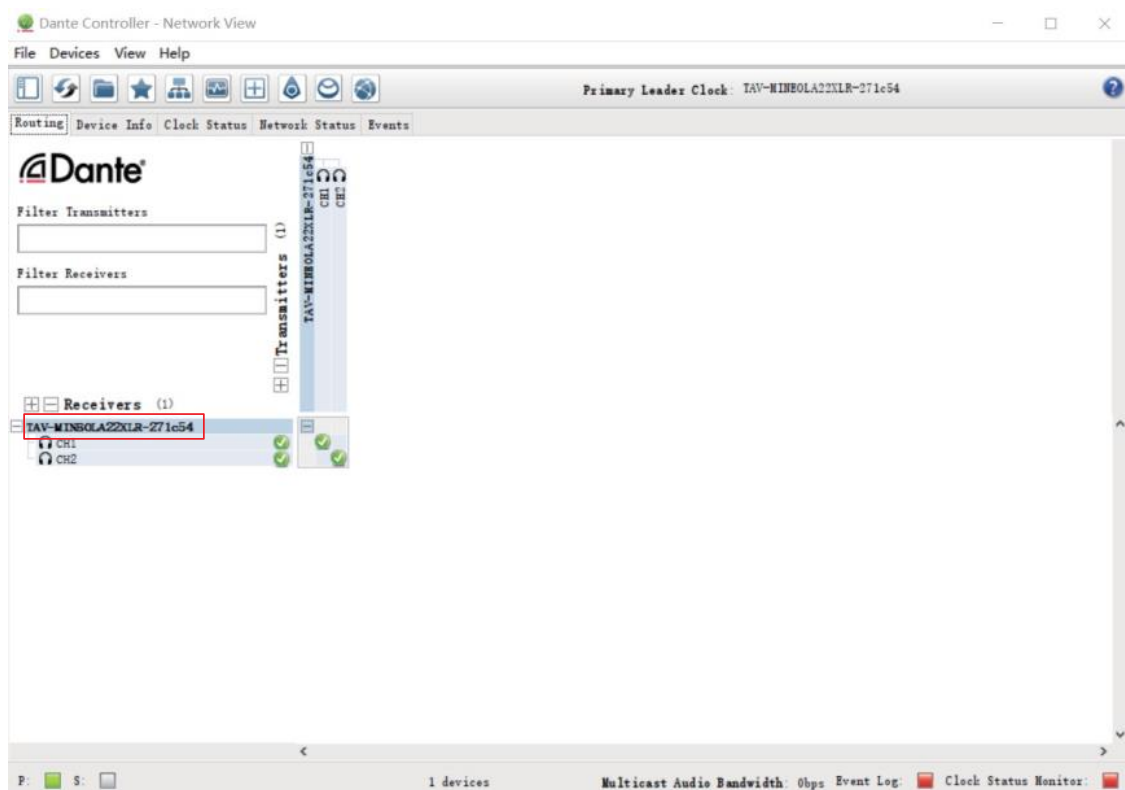

Step 4: Click the Device Info tab to check the IP address of the Dante® device.

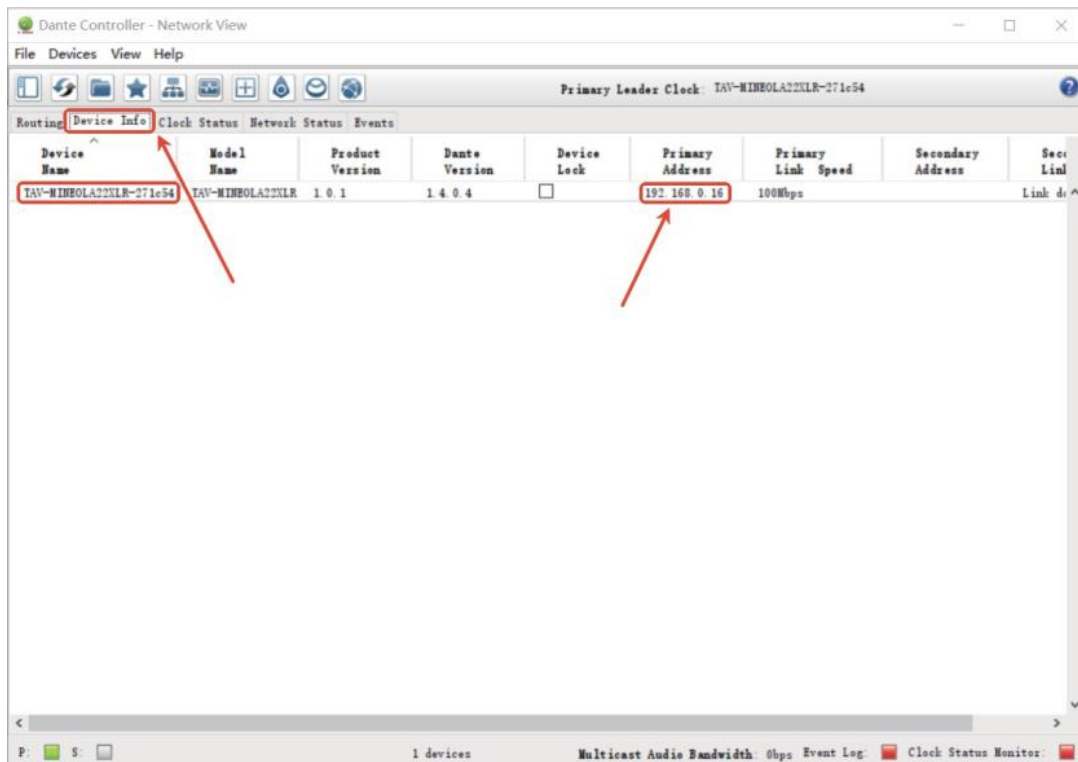

Step 5: Input the IP address of Dante® device into your browser on the PC to enter the login interface of the Dante® Web GUI.

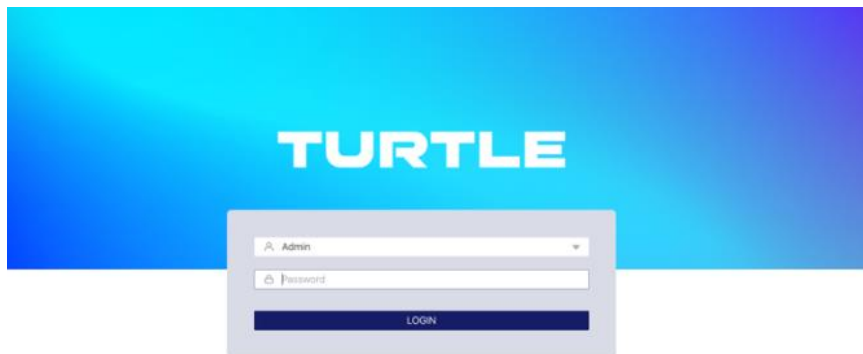

The default usernames and passwords are as below:

Username	Password
Admin	1234
User	1234

Step 6: Select the default username “Admin” and input the password “1234”, then click the “LOGIN” button to enter the Information page of Dante® Web GUI.

■ Information Page

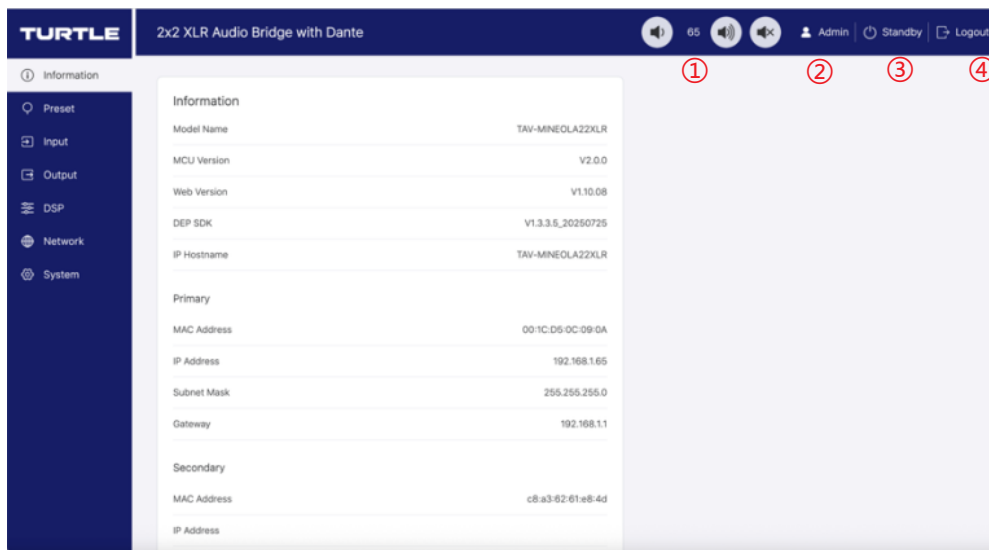

This page provides basic information about the audio bridge, such as Model Name, MCU Version, Web Version, DEP SDK, IP Hostname and Network configuration information of the primary network and secondary network.

Besides, you can do the following operations in the upper right corner of each page.

- ① Display and set the audio volume of Master Out. Click the volume icons to increase/decrease the audio volume of Master Out, or click the mute icon to mute/unmute the audio of Master Out. When muted, the mute icon displays red.
- ② Display the current username (User or Admin).
- ③ Click the power icon to power on the audio bridge or set it in standby mode.
- ④ Click the logout icon to logout and return to the login interface.

■ Preset Page

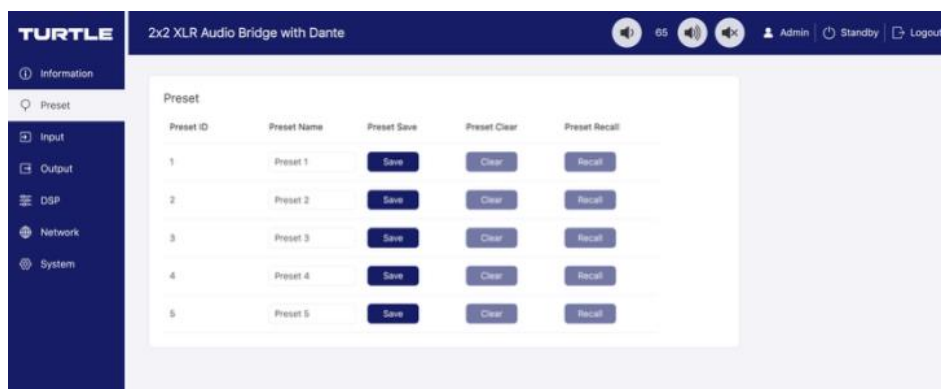

Up to 5 preset scenes can be set on the Preset page.

- ① **Preset Name:** You can name the preset scene (32 characters max).
- ② **Preset Save:** Click the Save button to save the scene.
- ③ **Preset Clear:** Click the Clear button to clear the saved scene.
- ④ **Preset Recall:** Click the Recall button to recall the saved scene.

■ Input Page



Input Setting

① **XLR IN 1/XLR IN 2:** You can respectively set the volume or mute/unmute the input audio for XLR IN 1/XLR IN 2.

Note: The name of the input channel “XLR IN 1/XLR IN 2” can be modified as required (32 characters max).

② **Sensitivity:** Click the drop-down list to respectively select the sensitivity value (+24dBu/+14dBu/0dBu/-18dBu/-35dBu) for XLR IN 1/XLR IN 2.

③ **Phantom Power:** Click the Phantom Power switch to respectively turn on/off the phantom power for XLR IN 1/XLR IN 2. When the Phantom Power switch is turned on, the XLR IN 1/XLR IN 2 port on the rear panel of the audio bridge can supply power to the connected MIC.

■ Output Page



Output Setting

① **Master Out:** Set the audio volume or mute/unmute the audio for Master Out when turning on both the switches of XLR OUT 1 and XLR OUT 2. Besides, you can turn on/off the switch of XLR OUT 1/XLR OUT 2 to respectively set the output volume or mute/unmute the output audio for XLR OUT 1/XLR OUT 2.

② **XLR OUT 1/XLR OUT 2:** Click the drop-down list to respectively select the gain value (+20dBu/+14dBu/0dBu/-18dBu) for XLR OUT 1/XLR OUT 2. In addition, you can respectively set the delay, increase/decrease the audio or mute/unmute the audio.

Note: The name of the output channel “XLR OUT 1/XLR OUT 2” can be modified as required (32 characters max).

■ DSP Page

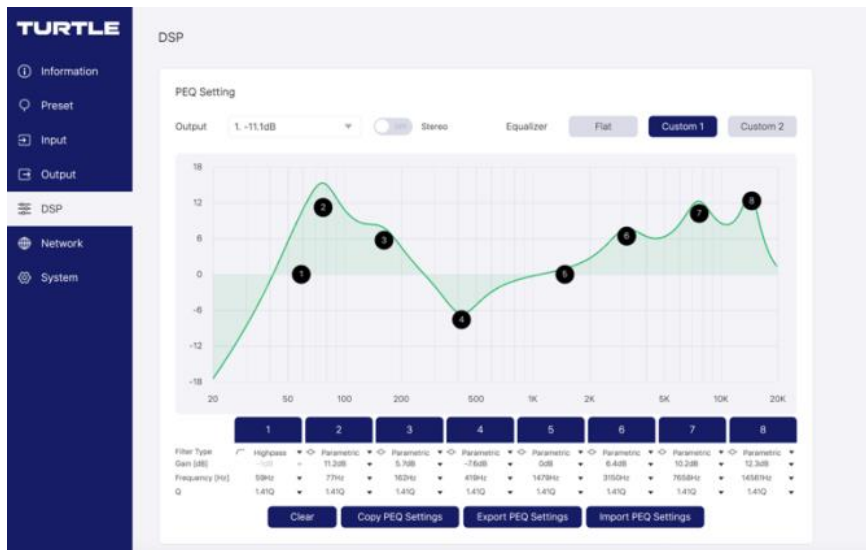

PEQ Setting

- ① **Output:** Click the drop-down list to select the input/output channel (XLR IN 1/XLR IN 2/ XLR OUT 1/XLR OUT 2).
- ② **Stereo:** Click the switch to turn on/off the stereo mode.
- ③ **Equalizer:** Click the buttons to set the equalizer.
Flat: Set all EQ to 0db.
Custom1: Set EQ for custom 1.
Custom2: Set EQ for custom 2.
- ④ **1/2/3/4/5/6/7/8:** 8 band buttons of PEQ. Blue grid indicates that the corresponding band is selected, and then you can set the parameters for it. For example, you can click the drop-down icon to set the filter type, gain, frequency and Q value respectively.
- ⑤ **Clear:** Click the button to clear the settings.
- ⑥ **Copy PEQ Settings:** Click the button to copy PEQ settings.
- ⑦ **Export PEQ Settings:** Click the button to export PEQ settings.
- ⑧ **Import PEQ Settings:** Click the button to import PEQ settings.

■ Network Page

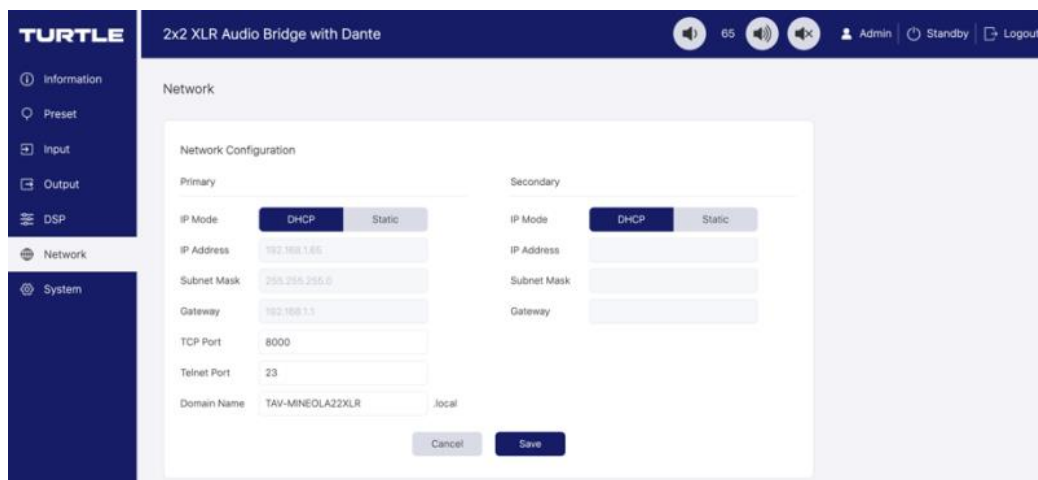

Network Configuration: Select to set the IP Mode (DHCP/Static) for the primary/secondary network. When Static is selected, you can manually set the IP Address, Subnet Mask and Gateway as required, then click “Save” to take effect. When DHCP is selected, the system will search and fill the IP Address with the one assigned by the router automatically. In addition, you can set the TCP Port, Telnet Port and Domain Name.

Note: The Domain Name “XLR22.local” can be used to login to the Dante® Web GUI. After setting up, click “Save” to take effect, or you can click “Cancel” to cancel the setting.

■ System Page

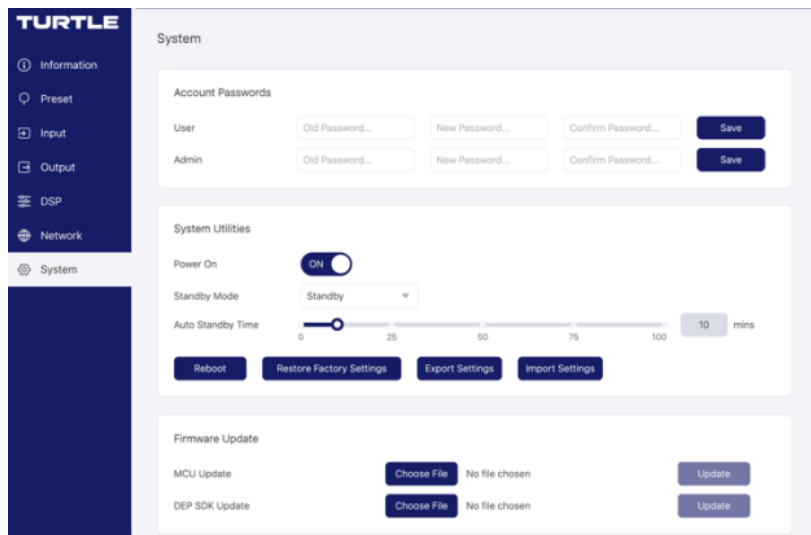

Account Passwords: You can modify the login password for User and Admin. After setting up, click “Save” to take effect.

System Utilities

- ① **Power On:** Click the switch to power on/off the audio bridge.
- ② **Standby Mode:** Click the drop-down list to select the standby/sleep mode.
- ③ **Auto Standby Time:** Drag the slider or directly enter the value to set the auto standby time.
- ④ **Reboot:** Click this button to reboot the audio bridge.
- ⑤ **Restore Factory Settings:** Click this button to restore the audio bridge to factory settings.
- ⑦ **Export Settings:** Click this button to export configuration files.
- ⑧ **Import Settings:** Click this button to import configuration files.

Firmware Update: You can update the firmware. Click “Choose File” to select the update file, then click “Update” to start update. When the progress bar reaches 100%, the update is complete.

In the Login interface, select the username “User” and input the password “1234”, then click the “LOGIN” button to enter the User page.

■ User Page

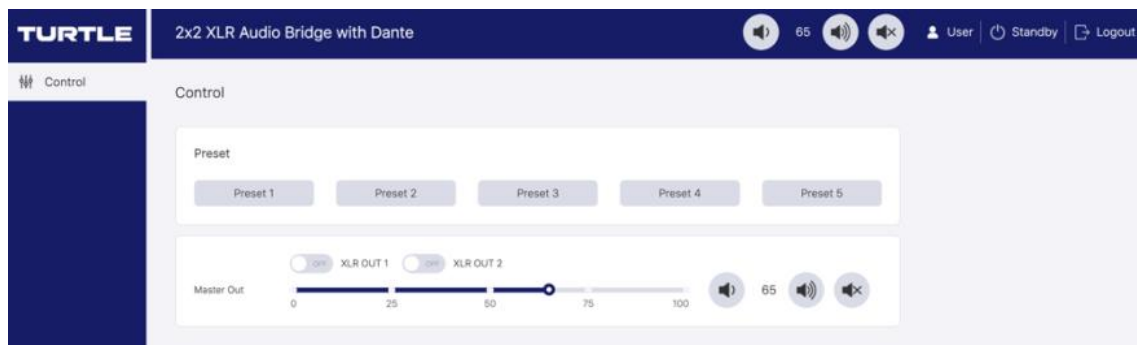

You can do the following operations on the User page:

- ① **Preset:** Recall the preset application scenes.
- ② **Master Out:** Set the audio volume or mute/unmute the audio for Master Out when turning on both the switches of XLR OUT 1 and XLR OUT 2. Besides, you can turn on/off the switch of XLR OUT 1/XLR OUT 2 to respectively set the output volume or mute/unmute the output audio for XLR OUT 1/XLR OUT 2.

2. API Control Command

The audio bridge also supports API command control. Connect the Dante® PRIMARY(PoE)/SECONDARY(PoE) port of the audio bridge and a PC to the same Switch, and set all devices in the same LAN. Then open a Serial Command tool on PC to send ASCII commands to control the audio bridge.

The ASCII command list about the product is shown as below.

ASCII Command				
Communication Protocol: TCP/IP port: 8000				
x - Parameter 1, y - Parameter 2				
Command Code	Function Description	Example	Feedback	Default Setting
System Setting				
?	Get the list of all commands	?	List all API commands	
help	Get the list of all commands	help	List all API commands	
get type	Get device model	get type	XLR22	
get status	Get device current status	get status	Please refer to the note at the end of the list.	
get fw version	Get Firmware version	get fw version	Web: V1.00.02 MCU: V2.0.0 DEP: V1.3.3.5_20250519	
set power on	Power on the device	set power on	Power on System Initializing... Initialization Finished! Web: V1.00.02 MCU: V2.0.0 DEP: V1.3.3.5_20250519	
set power off	Power off the device	set power off	Power: off	
get power	Get current power state	get power	Power: off	
set standby x	Set standby mode to x x=[1-2] 1:Standby, 2:Sleep	set standby 1	Standby mode: standby	1

Command Code	Function Description	Example	Feedback	Default Setting
get standby	Get standby mode	get standby	Standby mode: standby	
set reboot	Reboot the device	set reboot	Reboot... System Initializing... Initialization Finished! Web: V1.00.03 MCU: V2.0.0 DEP: V1.3.3.5_20250226	
set reset	Reset system settings to default (Should type "Yes" to confirm, "No" to discard)	set reset	Sure to Reset System Settings To Default? Type "Yes" after next prompt to confirm...	
set reset all	Reset system and network settings to default (Should type "Yes" to confirm, "No" to discard)	set reset all	Sure to Reset System and Network Settings To Default? Type "Yes" after next prompt to confirm...	
set auto stb x	Set system auto standby time x=0: Auto standby off x=[1-100]: Auto standby time (mins)	set auto stb 10	Auto standby time: 10mins	10
get auto stb	Get system auto standby time	get auto stb	Auto standby time: 10mins	
Input Setting				
set input x gain y	Set input:x gain to y x=[0-2] 0:All Inputs, 1:XLR IN1, 2:XLR IN2, y=[-12~12]dB Input gain value, Step=0.1dB	set input 1 gain 10	XLR IN1 gain: 10dB	0
get input x gain	Get input:x gain value x=[0-2] 0:All Inputs, 1:XLR IN1, 2:XLR IN2	get input 1 gain	XLR IN1 gain: 10dB	
set input x sensitivity y	Set input:x sensitivity to y x=[0-2] 0:All Inputs, 1:XLR IN1, 2:XLR IN2, y=[-1-6] 1: +24dBu, 2: +14dBu, 3: +4dBu, 4: 0dBV, 5: -18dBV, 6: -35dBV	set input 3 sensitivity 1	XLR IN3 sensitivity: +24dBu	0dBV
get input x sensitivity	Get input:x sensitivity x=[0-2] 0:All Inputs, 1:XLR IN1, 2:XLR IN2	get input 3 sensitivity	XLR IN3 sensitivity: +24dBu	
set input x phantom power on/off	Set input:x 48V phantom power on/off x=[0-2] 0:All Inputs, 1:XLR IN1, 2:XLR IN2	set input 3 phantom power on	XLR IN3 phantom power: on	Off
get input x phantom power	Get input:x 48V phantom power status x=[0-2] 0:All Inputs, 1:XLR IN1, 2:XLR IN2	get input 3 phantom power	XLR IN3 phantom power: on	

Command Code	Function Description	Example	Feedback	Default Setting
set input x gain+ set input x gain+y	Increase input:x gain by y x=[0-2] 0:All Inputs, 1:XLR IN1, 2:XLR IN2, y=[0.1-24]:Steps, y can be empty (Step=1dB)	set input 1 gain+ set input 1 gain+5	Increase XLR IN1 gain: 1dB Increase XLR IN1 gain: 5dB	
set input x gain- set input x gain-y	Decrease input:x gain by y x=[0-2] 0:All Inputs, 1:XLR IN1, 2:XLR IN2, y=[0.1-24]:Steps, y can be empty (Step=1dB)	set input 1 gain- set input 1 gain-5	Decrease XLR IN1 gain: -1dB Decrease XLR IN1 gain: -5dB	
set input x mute on/off	Set input:x mute on/off x=[0-2] 0:All Inputs, 1:XLR IN1, 2:XLR IN2	set input 1 mute on	XLR IN1 mute: on	Off
get input x mute	Get input:x mute on/off x=[0-2] 0:All Inputs, 1:XLR IN1, 2:XLR IN2	get input 1 mute	XLR IN1 mute: on	
Output Setting				
set master member <ab>	Set master output member (a/b=0-1) a/b=0: Exclude the member a/b=1: Include the member a: XLR OUT1 b: XLR OUT2	set master member <11>	Set master member: 11	11
get master member	Get master output member	get master member	111111	
set master vol x set vol x	Set master output volume to x x=[0-100] volume value	set master vol 50 set vol 50	Master volume: 50	50
get master vol get vol	Get master output volume	get master vol get vol	Master volume: 50	
set master vol+ set vol+ set master vol+y set vol+y	Increase master output volume Increase master output volume by y y=[1-100]: Steps, y can be empty (Step=1dB)	set master vol+ set vol+ set master vol+5 set vol+5	Increase master volume: 51 Increase master volume: 51 Increase master volume: 55 Increase master volume: 55	
set master vol- set vol- set master vol-y set vol-y	Decrease master output volume Decrease master output volume by y. y=[1-100]: Steps, y can be empty (Step=1dB)	set master vol- set vol- set master vol-5 set vol-5	Decrease master volume: 49 Decrease master volume: 49 Decrease master volume: 45 Decrease master volume: 45	
set master mute on/ off set mute on/off	Set master output mute on/of	set master mute on set mute on	Master mute: on	Off
get master mute get mute	Get master output mute on/off status	get master mute get mute	Master mute: on	

Command Code	Function Description	Example	Feedback	Default Setting
set output x gain y	Set output:x gain to y x=[0-2] 0:All Outputs, 1:XLR OUT1, 2:XLR OUT2, y=[1-6] 1:+20dBu, 2:+14dBu, 3:+4dBu, 4:0dBV, 5:-18dBV, 6:-35dBV	set output 3 gain 1	XLR OUT3 sensitivity: +20dBu	
get output x gain	Get output:x gain x=[0-2] 0:All Outputs, 1:XLR OUT1, 2:XLR OUT2	get output 3 gain	XLR OUT3 sensitivity: +20dBu	
set output x vol y	Set output:x volume to y x=[0-2] 0:All Outputs, 1:XLR OUT1, 2:XLR OUT2 y=[0-100] volume value	set output 5 vol 50	XLR OUT5 volume: 50	50
get output x vol	Get output:x volume value x=[0-2] 0:All Outputs, 1:XLR OUT1, 2:XLR OUT2	get output 5 vol	XLR OUT5 volume: 50	
set output x vol+ set output x vol+y	Increase output:x volume by y x=[0-2] 0:All Outputs, 1:XLR OUT1, 2:XLR OUT2 y=[1-100]:Steps, y can be empty (Step=1)	set output 5 vol+ set output 5 vol+5	Increase XLR OUT5 volume: 51 Increase XLR OUT5 volume: 55	
set output x vol- set output x vol-y	Decrease output:x volume by y x=[0-2] 0:All Outputs, 1:XLR OUT1, 2:XLR OUT2 y=[1-100]:Steps, y can be empty (Step=1)	set output 5 vol- set output 5 vol-5	Decrease XLR OUT5 volume: 49 Decrease XLR OUT5 volume: 45	
set output x mute on/off	Set output:x mute on/off x=[0-2] 0:All Outputs, 1:XLR OUT1, 2:XLR OUT2	set output 5 mute on	XLR OUT5 mute: on	Off
get output x mute	Get output:x mute on/off status x=[0-2] 0:All Outputs, 1:XLR OUT1, 2:XLR OUT2	get output 5 mute	XLR OUT5 mute: on	
set output x delay y	Set output:x delay:y x=[0-2] 0:All Outputs, 1:XLR OUT1, 2:XLR OUT2 y=[0-50]: Delay Time, Millisecond	set output 5 delay 50	XLR OUT5 delay: 50ms	0
get output x delay	Get output:x delay value x=[0-2] 0:All Outputs, 1:XLR OUT1, 2:XLR OUT2	get output 5 delay	XLR OUT5 delay: 50ms	

Command Code	Function Description	Example	Feedback	Default Setting
DSP Setting				
set input x eq preset y	Set input:x PEQ:yy To preset:yy x=[0-2] 0:All Inputs, 1:XLR IN1, 2:XLR IN2 y=[1-3] 1:Flat, 2:Custom1, 3:Custom2	set input 1 eq preset 2	XLR IN1 PEQ: Custom1	
get input x eq preset	Get input:x PEQ preset status x=[0-2] 0:All Inputs, 1:XLR IN1, 2:XLR IN2	get input 1 eq preset	XLR IN1 PEQ: Custom1	
set input x eq y on/off	Set input:x EQ index:y on/off x=[0-2] 0:All Inputs, 1:XLR IN1, 2:XLR IN2 y=[0-8]: EQ index 0:All	set input 1 eq 0 on	XLR IN1 EQ all: on	Off
get input x eq	Get input:x EQ on/off status x=[0-2] 0:All Inputs, 1:XLR IN1, 2:XLR IN2	get input 1 eq	XLR IN1 EQ: on	
set input x eq stereo on/off	Set input:x EQ stereo mode (same EQ settings) on/off x=[0-1] 0:All Inputs, 1:XLR IN1/2	set input 1 eq stereo on	XLR IN1/2 EQ stereo mode: on	Off
get input x eq stereo	Get input:x EQ stereo mode (same EQ settings) on/off status x=[0-1] 0:All Inputs, 1:XLR IN1/2	get input 1 eq stereo	XLR IN1/2 EQ stereo mode: on	
set input x eq y typ t frq z val aa q bb	Set input:x EQ index:y TYP t to FRQ z VAL aa Q bb x=[0-2] 0:All Inputs, 1:XLR IN1, 2:XLR IN2 y=[0-8]: EQ index 0:All t=[1-5] 1:Parametric, 2:Lowpass, 3:Highpass, 4:Low Shelf, 5:High Shelf z=[20-20000]: Frequency value (Step=0.1Hz) aa=[-15~15]: Gain value (Step=0.1dB) bb=[0.02~16]: Q value (Step=0.01)	set input 1 eq 1 typ 1 frq 200 val -18 q 0.02	XLR IN1 EQ : Type: 2, Frequency: 1000Hz, Value: 12dB, Q: 1.4	

Command Code	Function Description	Example	Feedback	Default Setting
get input x eq setting	Get input:x EQ index:y value x=[0-2] 0:All Inputs, 1:XLR IN1, 2:XLR IN2	get input 1 eq setting	Dante XLR IN1 EQ 1: Type: 2, Frequency: 1000Hz, Value: 12dB, Q: 1.4 on 2: Type: 2, Frequency: 1000Hz, Value: 12dB, Q: 1.4 on 3: Type: 2, Frequency: 1000Hz, Value: 12dB, Q: 1.4 on 4: Type: 2, Frequency: 1000Hz, Value: 12dB, Q: 1.4 on 5: Type: 2, Frequency: 1000Hz, Value: 12dB, Q: 1.4 on 6: Type: 2, Frequency: 1000Hz, Value: 12dB, Q: 1.4 on 7: Type: 2, Frequency: 1000Hz, Value: 12dB, Q: 1.4 on 8: Type: 2, Frequency: 1000Hz, Value: 12dB, Q: 1.4 on	
set input x eq clear	Clear input:x EQ setting x=[0-2] 0:All Inputs, 1:XLR IN1, 2:XLR IN2	set input 1 eq clear	Clear XLR IN1 EQ	
set output x eq preset y	Set output:x PEQ:yy To preset:yy x=[0-2] 0:All Outputs, 1:XLR OUT1, 2:XLR OUT2 y=[1-3] 1: Flat, 2: Custom1, 3: Custom2	set output 1 eq preset 2	XLR OUT1 PEQ: Custom1	
get output x eq preset	Get output:x PEQ preset status x=[0-2] 0:All Outputs, 1:XLR OUT1, 2:XLR OUT2	get output 1 eq preset	XLR OUT1 PEQ: Custom1	
set output x eq y on/off	Set output:x EQ index:y on/off x=[0-2] 0:All Outputs, 1:XLR OUT1, 2:XLR OUT2 y=[0-8]: EQ index 0:All	set output 1 eq 0 on	XLR OUT1 EQ 1: on XLR OUT1 EQ 2: on XLR OUT1 EQ 3: on XLR OUT1 EQ 4: on XLR OUT1 EQ 5: on XLR OUT1 EQ 6: on XLR OUT1 EQ 7: on XLR OUT1 EQ 8: on	
get output x eq	Get output:x EQ on/off status x=[0-2] 0:All Outputs, 1:XLR OUT1, 2:XLR OUT2	get output 1 eq	XLR OUT1 EQ: on	
set output x eq stereo on/off	Set output:x EQ stereo mode (same EQ settings) on/off x=[0-2] 0:All Outputs, 1:XLR OUT1/2	set output 1 eq stereo on	XLR OUT1/2 EQ stereo mode: on	Off
get output x eq stereo	Get output:x EQ stereo mode (same EQ settings) on/off status x=[0-2] 0:All Outputs, 1:XLR OUT1/2	get output 1 eq stereo	XLR OUT1/2 EQ stereo mode: on	

Command Code	Function Description	Example	Feedback	Default Setting
set output x eq y typ t frq z val aa q bb	Set output:x EQ index:y TYP t to FRQ z VAL aa Q bb x=[0-2] 0:All Outputs, 1:XLR OUT1, 2:XLR OUT2 y=[0-8]: EQ index 0:All t=[1-5] 1:Parametric, 2:Lowpass, 3:Highpass, 4:Low Shelf, 5:High Shelf z=[20-20000]: Frequency value (Step=0.1Hz) aa=[-15~15]: Gain value (Step=0.1dB) bb=[0.02~16]: Q value (Step=0.01)	set output 1 eq 1 typ 1 frq 200 val -18 q 0.02	XLR OUT1 EQ Type: 2, Frequency: 1000Hz, Value: 12dB, Q: 1.4	
get output x eq setting	Get output:x EQ index:y value x=[0-2] 0:All Outputs, 1:XLR OUT1, 2:XLR OUT2	get output 1 eq	Dante XLR OUT1 EQ 1: Type: 2, Frequency: 1000Hz, Value: 12dB, Q: 1.4 on 2: Type: 2, Frequency: 1000Hz, Value: 12dB, Q: 1.4 on 3: Type: 2, Frequency: 1000Hz, Value: 12dB, Q: 1.4 on 4: Type: 2, Frequency: 1000Hz, Value: 12dB, Q: 1.4 on 5: Type: 2, Frequency: 1000Hz, Value: 12dB, Q: 1.4 on 6: Type: 2, Frequency: 1000Hz, Value: 12dB, Q: 1.4 on 7: Type: 2, Frequency: 1000Hz, Value: 12dB, Q: 1.4 on 8: Type: 2, Frequency: 1000Hz, Value: 12dB, Q: 1.4 on	
set output x eq clear	Clear output:x EQ setting x=[0-2] 0:All Outputs, 1:XLR OUT1, 2:XLR OUT2	set output 1 eq clear	Clear XLR OUT1 EQ	
set input/output x eq copy to input/ output y	Set input/output:x EQ copy to input/output:y x=[1-8] 1:XLR IN/OUT1, 2:XLR IN/OUT2, y=[0-8] 0:All Inputs/Outputs, 1:XLR IN/OUT1, 2:XLR IN/OUT2	set input 1 eq copy to output 2	Set XLR IN1 EQ copy to XLR OUT2	
Preset Setting				
set preset save x	Save the current unit's settings to preset:x All settings except network setting. x=[1-5]: Preset 1 - Preset 5	set preset save 1	Save to preset 1	
set preset recall x	Recall preset:x into unit All settings except network setting. x=[1-5]: Preset 1 - Preset 5	set preset recall 1	Recall preset 1	
set preset clear x	Clear preset:x All settings except network setting. x=[1-5]: Preset 1 - Preset 5	set preset clear 1	Clear preset 1	

Command Code	Function Description	Example	Feedback	Default Setting
Network Setting				
get ipconfig	Get the current IP configuration	get ipconfig	TCP/IP port: 8000 Telnet port: 23 Primary: IP mode: DHCP IP: 192.168.0.6 Subnet mask: 255.255.255.0 Gateway: 192.168.0.1 MAC: 34:D0:B8:27:1C:5B Static: (192.168.0.3 255.255.255.0 192.168.0.1) Secondary: IP mode: DHCP IP: 172.31.54.2 Subnet mask: 255.255.0.0 Gateway: 172.31.0.1 MAC: 34:D0:B8:27:1C:58 Static: (192.168.10.31 255.255.255.0 192.168.10.1)	
get pri mac addr	Get primary network MAC address	get pri mac addr	Primary MAC: 6C:DF:FB:0C:B3:8E	
set pri ip mode x	Set primary network IP mode to static IP or DHCP x=[0-1] 0. Static, 1. DHCP	set pri ip mode 0	Primary IP mode: Static (Please use "s net reboot!" command or repower device to apply new config!)	1
get pri ip mode	Get primary network IP mode	get pri ip mode	Primary IP mode: DHCP	
set pri ip addr xxx.xxx.xxx.xxx	Set primary network IP address	set pri ip addr 192.168.1.100	Primary IP address: 192.168.0.100 (Please use "s net reboot!" command or repower device to apply new config!) DHCP on, Device can't config static address, set DHCP off first.	
get pri ip addr	Get primary network IP address	get pri ip addr	Primary IP: 192.168.0.100	
set pri subnet xxx.xxx.xxx.xxx	Set primary network subnet mask	set pri subnet 255.255.255.0	Primary Subnet Mask: 255.255.255.0 (Please use "s net reboot!" command or repower device to apply new config!) DHCP on, Device can't config subnet mask, set DHCP off first.	
get pri subnet	Get primary network subnet mask	get pri subnet	Primary Subnet Mask: 255.255.255.0	
set pri gateway xxx.xxx.xxx.xxx	Set primary network gateway	set pri gateway 192.168.1.1	Primary Gateway: 192.168.1.1 (Please use "s net reboot!" command or repower device to apply new config!) DHCP on, Device can't config gateway, set DHCP off first.	
get pri gateway	Get primary network gateway	get pri gateway	Primary Gateway: 192.168.1.1	

Command Code	Function Description	Example	Feedback	Default Setting
get sec mac addr	Get secondary network MAC address	get sec mac addr	Secondary MAC: 6C:DF:FB:0C:B3:8E	
set sec ip mode x	Set secondary network IP mode to static IP or DHCP x=[0-1] 0. Static, 1. DHCP	set sec ip mode 0	Secondary IP mode: Static (Please use "s net reboot!" command or repower device to apply new config!)	1
get sec ip mode	Get secondary network IP mode	get sec ip mode	Secondary IP mode: DHCP	
set sec ip addr xxx.xxx.xxx.xxx	Set secondary network IP address	set sec ip addr 192.168.1.100	Secondary IP address: 192.168.0.100 (Please use "s net reboot!" command or repower device to apply new config!) DHCP on, Device can't config static address, set DHCP off first.	
get sec ip addr	Get secondary network IP address	get sec ip addr	Secondary IP: 192.168.0.100	
set sec subnet xxx.xxx.xxx.xxx	Set secondary network subnet mask	set sec subnet 255.255.255.0	Secondary Subnet Mask: 255.255.255.0 (Please use "s net reboot!" command or repower device to apply new config!) DHCP on, Device can't config subnet mask, set DHCP off first.	
get sec subnet	Get secondary network subnet mask	get sec subnet	Secondary Subnet Mask: 255.255.255.0	
set sec gateway xxx.xxx.xxx.xxx	Set secondary network gateway	set sec gateway 192.168.1.1	Secondary Gateway: 192.168.1.1 (Please use "s net reboot!" command or repower device to apply new config!) DHCP on, Device can't config gateway, set DHCP off first.	
get sec gateway	Get secondary network gateway	get sec gateway	Secondary Gateway: 192.168.1.1	
set tcp/ip port x	Set network TCP/IP port (x=1~65535)	set tcp/ip port 8000	TCP/IP port: 8000	8000
get tcp/ip port	Get network TCP/IP port	get tcp/ip port	TCP/IP port: 8000	
set telnet port x	Set network telnet port (x=1~65535)	set telnet port 23	Telnet port: 23	23
get telnet port	Get network telnet port	get telnet port	Telnet port: 23	
set net reboot	Reboot network modules	set net reboot	Search for IP, Please wait ...! IP Mode: DHCP IP: 192.168.62.106 Subnet Mask: 255.255.255.0 Gateway: 192.168.62.1 TCP/IP port: 8000 MAC: 6C:DF:FB:0C:B3:8E (Static: 169.254.100.200 255.255.0.0 169.254.100.1)	

Command Code	Function Description	Example	Feedback	Default Setting
Password Setting				
set admin password x	Set admin login password (x=[16 characters max])	set admin password 1234	Admin password: 1234	1234
get admin password	Get admin login password	get admin password	Admin password: 1234	
set user password x	Set user login password (x=[16 characters max])	set user password 1234	User password: 1234	1234
get user password	Get user login password	get user password	User password: 1234	

Note: The feedback of the command of "r status" is as following.

```

=====
Status Info XLR22 Audio Bridge
Web v1.00.03 MCU v2.0.0 DEP v1.3.3.5_20250226

Power Standby Mode Auto_Standby Baud
On Sleep 10m in 115200

Input Name Phantom_Power Sensitivity Gain(dB) Mute
01 XLR IN1 Off 0dBV 0 Off
02 XLR IN2 Off 0dBV 0 Off

Output Name Gain Volume Mute Delay (ms)
01 XLR OUT1 0dBV 50 Off 0
02 XLR OUT2 0dBV 50 Off 0

TCP/IP Telnet MAC (PRIMARY) MAC (SECONDARY)
8000 0023 6C:DF:FB:0C:B3:8E 6C:DF:FB:0C:B3:88

PRIMARY
DHCP IP Gateway SubnetMask
On 192.168.062.111 192.168.062.001 255.255.000.000
(Static: 192.168.000.100 192.168.000.001 255.255.000.000)

SECONDARY
DHCP IP Gateway SubnetMask
On 192.168.062.111 192.168.062.001 255.255.000.000
(Static: 192.168.001.100 192.168.001.001 255.255.000.000)
=====

```

3. Connection Diagram

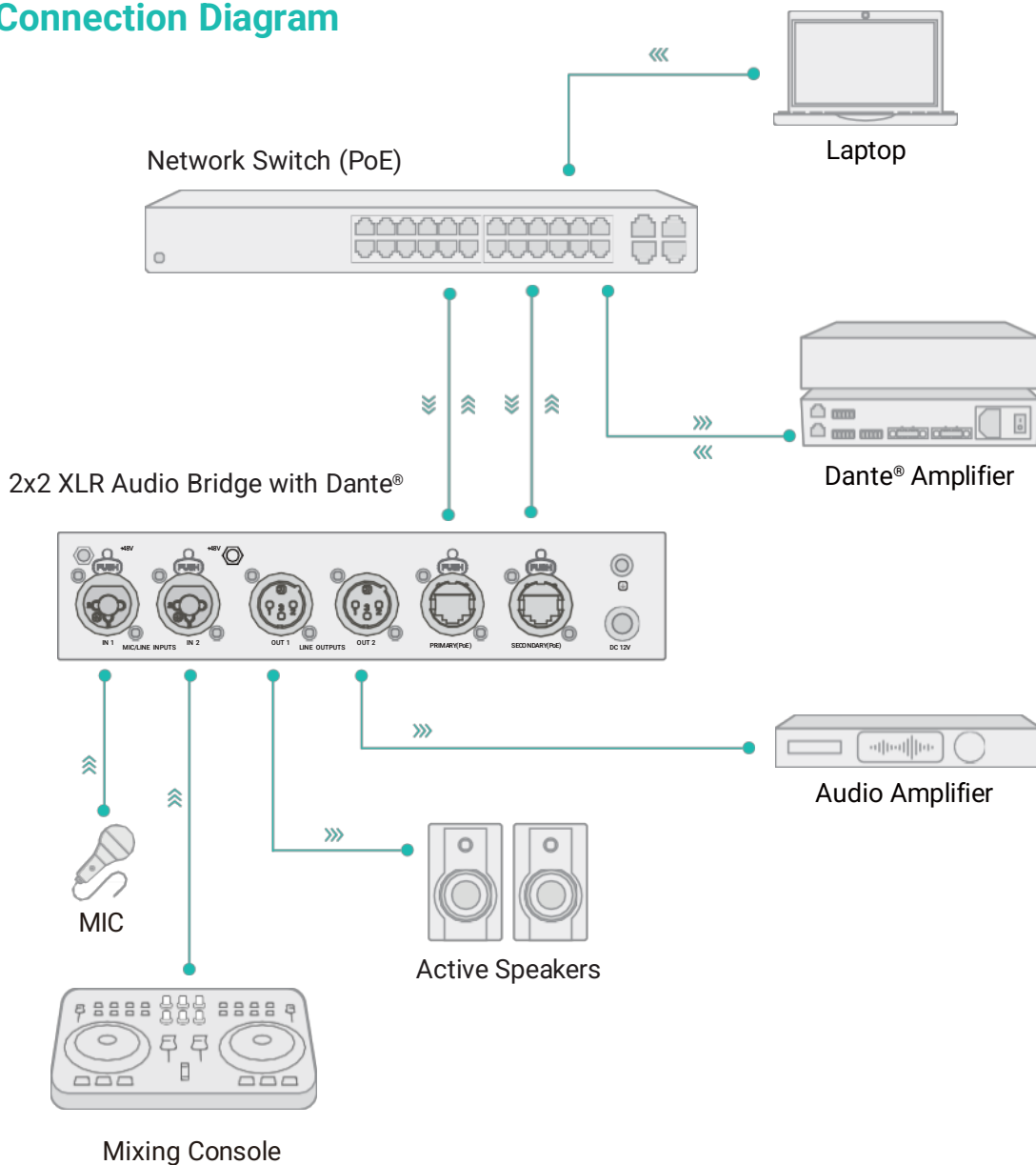

Note: Please pay attention to the XLR connector pinouts when connecting XLR audio input/output devices.

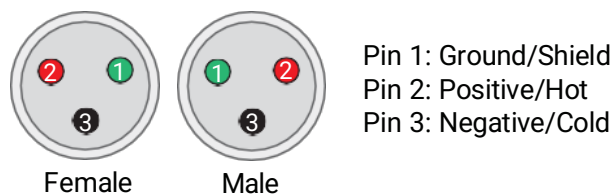

Trademarks

Dante® is registered trademark of Audinate Pty Ltd. All other trademarks are the property of their respective owners.